

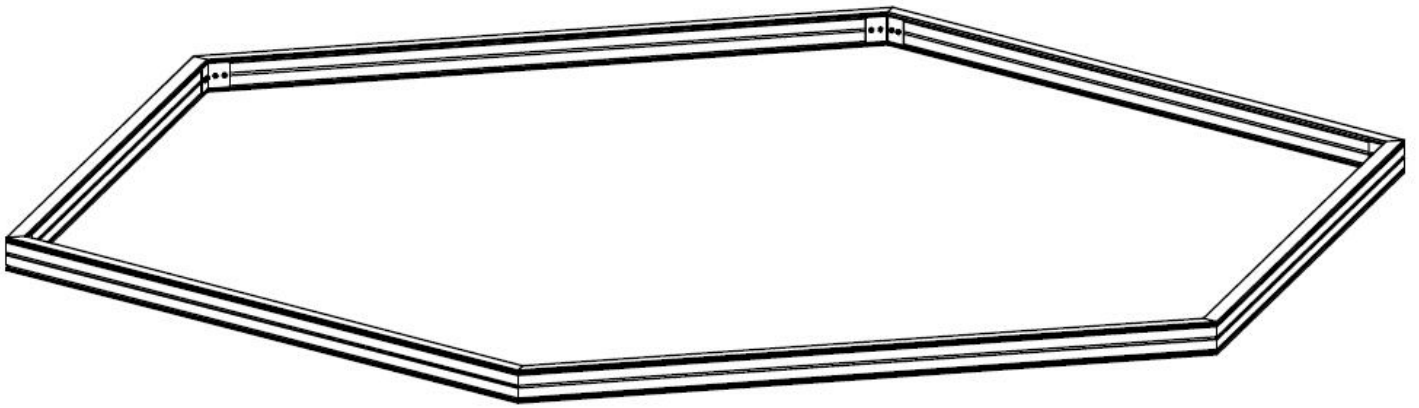









METALCRAFT

Monteringsanvisningar



MODELL: HG-B/HG-DG Aluminiumstomme

LÄS IGENOM NOGGRANT FÖRE MONTERING

DEL	NR.	ANTAL
 1932,8 mm	DJ01	6
	DJW07	6
	DJW03	17
 Ø9XØ17x1	DJW04	17
	DJW06	17
 Ø5X40	DJZ01	17
 M6X10	S01	24
 M6	M01	41
 TSM6X12	S02	17

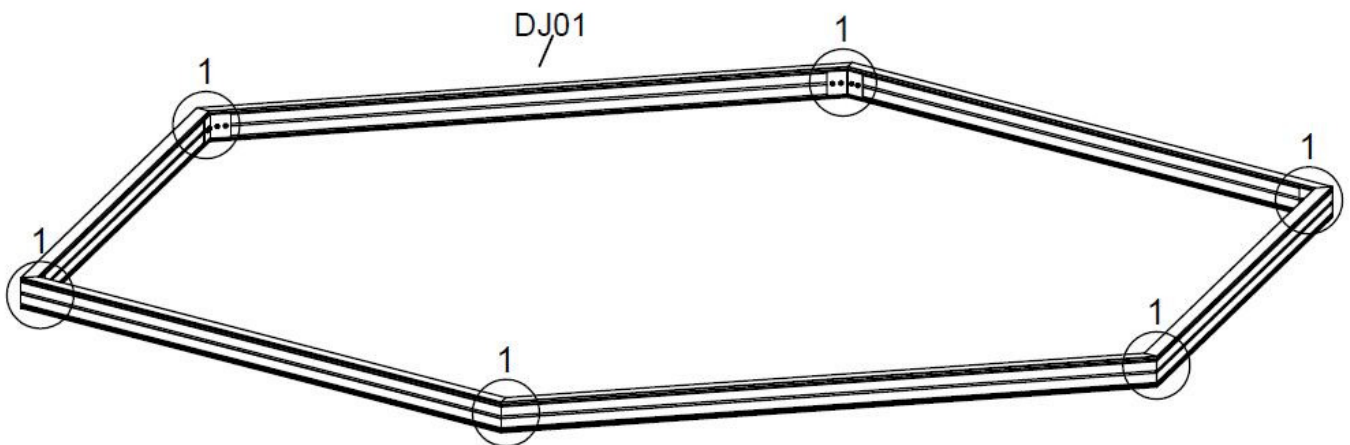

Montera ihop DJ01 (6 st.) med DJW07, spänn åt med S01 & M01.

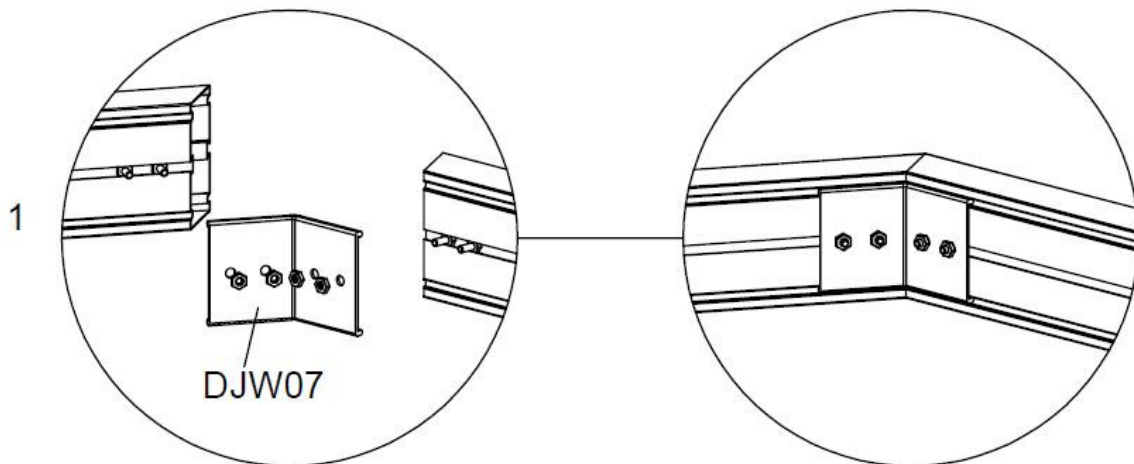

Lägg först ut socklarna, anslutningarna och ankarkonsolerna ungefär på plats, spänn sen åt dem med skruvarna och muttrarna.

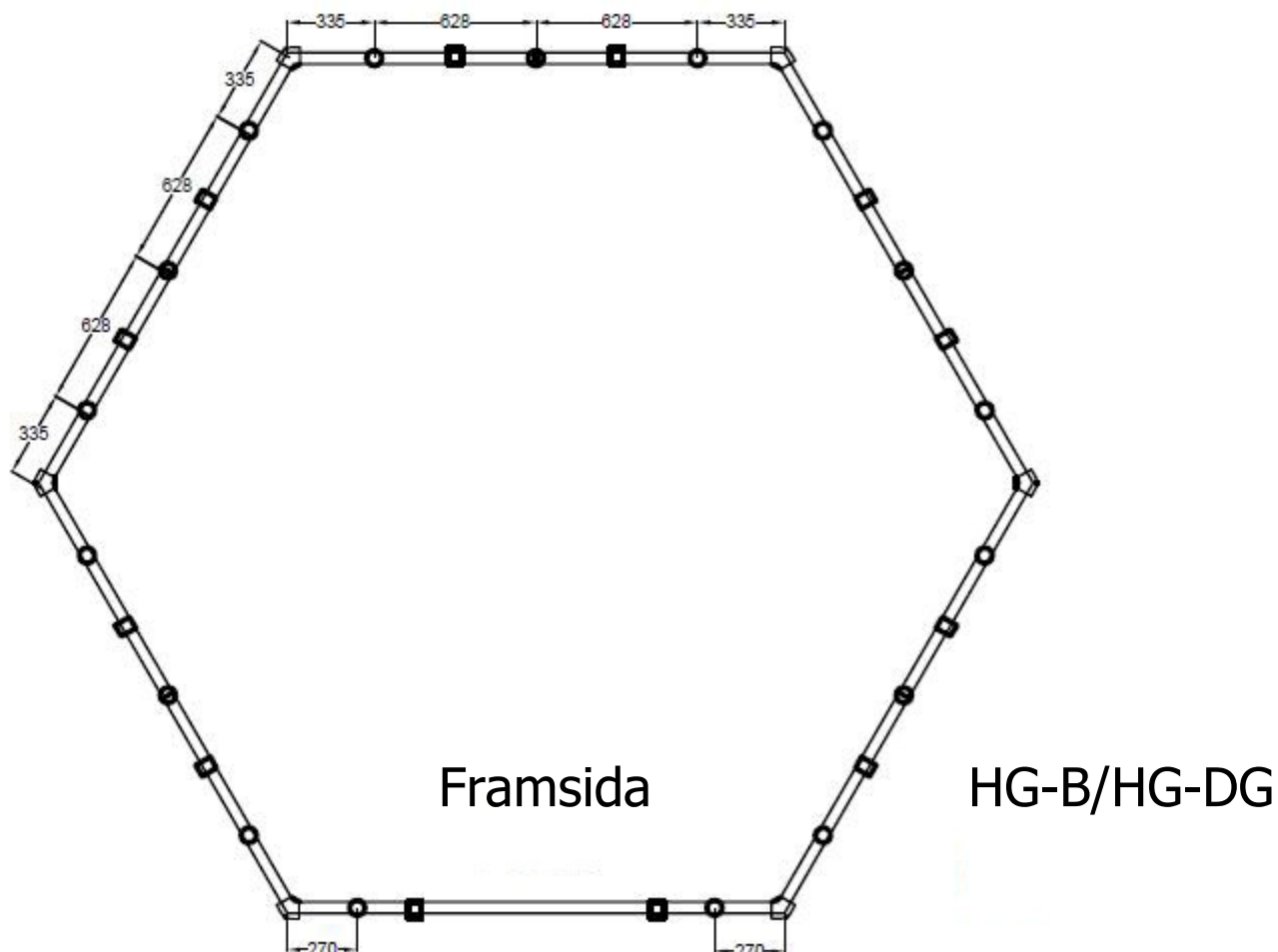

Ritningen visar placeringen av DJW03 & DJW06 mitt på varje sektion PC-skiva.

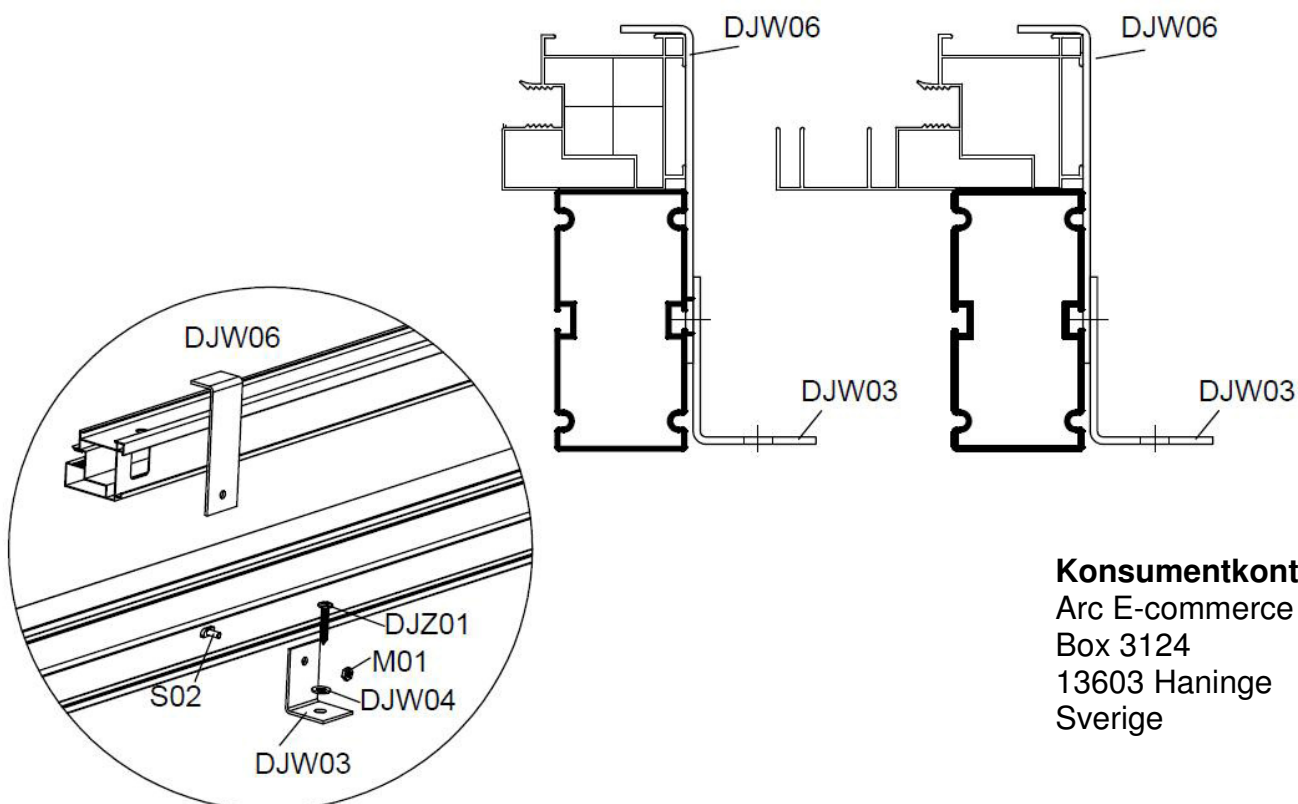

Konsumentkontakt
Arc E-commerce AB
Box 3124
13603 Haninge
Sverige